

WFD-30 Installation

This document is online at <http://www.wifitrax.com/appNotes/quickStart/WFD-30-Quick-Start.pdf>. Please consult the full WFD-30 manual for much more detail at <http://www.wifitrax.com/manuals/WFD-30/WFD-30-Manual.pdf>

Package Contents

1 x WFD-30 Module in Static Shielding Bag, Getting Started: WFD-30 Installation (this document), Mounting Kit

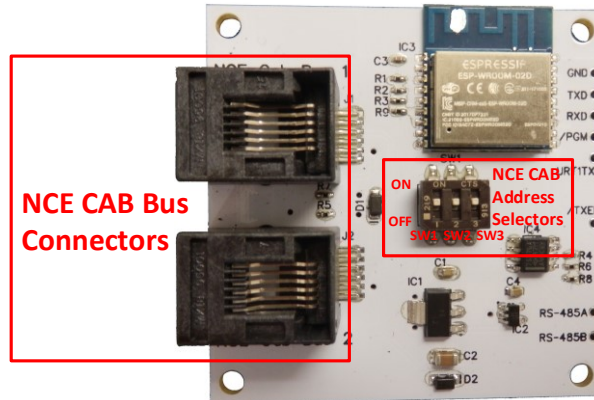

Figure 1. WFD-30 Connections

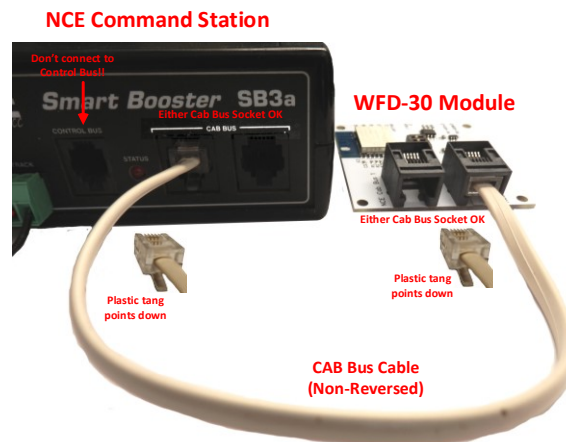

Figure 2. Connections to NCE Command Station

SW1	SW2	SW3	NCE CAB Bus Address
0	0	0	3
1	0	0	4
0	1	0	5
1	1	0	10 (default)
0	0	1	20
1	0	1	30 *
0	1	1	40 *
1	1	1	10 (Causes Factory Reset!)

Table 1 CAB Bus Address Selection Options (* Address 30 & 40 may be set to any CAB address using Web Pages)

This product is not a toy. Keep away from children. It is not suitable for use by persons under 14 years of age.
 Warning: This product contains chemicals known to the state of California to cause cancer, birth defects or other reproductive harm.

What does WFD-30 NEC Cab Bus Wi-Fi Interface do?

The WFD-30 allows you to drive your DCC trains from a hand-held untethered controller by providing a Wi-Fi connection to NCE command stations and boosters. It connects to one of the Cab Bus sockets on your NCE Command Station and provides Wi-Fi control of your DCC locos.

- You can drive trains using a smart phone or tablet as a hand-held controller provided it has Wi-Fi capability and you have installed one of our recommended apps in Table 2.
- You can use a hand-held throttle designed to control trains that uses the WiThrottle protocol authored and maintained by Brett Hoffman. Examples are Engine Driver on Android and WiThrottle on Apple.
- You can use a Windows or Apple computer, such as a laptop or desktop, with a recommended app from Table 2 installed.
- WDM-30 provides a Wi-Fi Access Point. Four throttles at a time can join but you can remove this limit using a “Home Net” as described in the manual.

If you have been using an app on your phone to drive trains, via a computer running JMRI, you can now bypass JMRI and connect your phone directly to the WFD-30.

You don't need to install JMRI to use the WFD-30

Installation Instructions

The WFD-30 should be mounted fairly near to your NCE Command Station so that you can connect to the command station's Cab Bus sockets.

- (1) **CAB Bus Address:** All CABs connected on the NCE Cab Bus must have a unique address. Use Table 1 to set the Address Switches to select an unused CAB address. The factory default is CAB Address 10. Please only use the Factory Reset option to cause a complete reset on cycling power then return the switches to another setting.
- (2) **Mounting:** The WFD-25 module is intended to receive power from the NCE CAB bus. No further power is required. Either mount the WFD-30 module on or under your baseboard or at any other suitable position where no tools or other metal items will contact it. A good option is to install the module in a suitably sized plastic box which you can obtain from your electronic hobby store. Consult the manual for a drilling template, suggestions and pictures.
- (3) **Connections:** Figure 1 shows the WFD-30 module with its connectors labelled. There are two NCE CAB Bus connections on the left of the module. Either of these can be connected to one of the CAB Bus connections on your NCE Command Station as in Figure 2. You should always use NON-REVERSED cables with RJ-12 6P4C Modular Plugs on each end – the coiled cables from NCE are ideal. **Warning: Some phone cables are reversed. The WDM-30 will not work with these but it will not be damaged.** The unused CAB Bus socket on the WDM-30 can be used to connect any other NCE Cab. See the section “More About Cables” in the manual if making your own cable. **If you are using a Power Cab, do not connect the flat cable to the spare connector on the WFD-30. Only connect the flat cable as instructed by NCE.**

Choosing and Installing your App

App Name	Author	Get From:	Windows 10	Android	Apple IOS	Advanced Features
Loco Operator 3	WifiTrax	Microsoft Store or Google Play Store	YES	YES	NO	YES *
WiThrottle	Beth Hoffman	Apple Store	NO	NO	YES	Via web page.
Engine Driver	Steve Todd	Google Play Store	NO	YES	NO	Via web page.
Train Throttle	Drew Hoffman	Microsoft Store	YES	NO	NO	

Table 2 Recommended Apps that work with the WFD-30

* WifiTrax Loco Operator 3 provides setup for the more advanced features such as Home Net operation, Rosters and Automatic Function Labels. This configuration may also be achieved via the web page using WiThrottle, Engine Driver or just a browser at the URL <http://192.168.7.1> once you have connected your computer or tablet to the WFD-30 access point.

You need to install an app on your phone, tablet or computer to use the WFD-30, Table 2 lists some recommended apps. Make your choice from Table 2 then make sure you are connected to the internet, visit the app store for your device manufacturer:



Search for the app by name, download and install the app.

Getting Started with WiThrottle on Apple IOS

There is a much more detailed description in the manual: <http://www.wifitrax.com/manuals/WFD-30/WFD-30-Manual.pdf>

- (1) Before opening the app, make sure your WFD-30 is properly connected, power to your NCE Command Station is on and there is a locomotive on the track with a known DCC address.
- (2) Tap the Settings icon on your iPhone or iPad, etc.



- (3) Tap Wi-Fi on the left-hand menu. Under CHOOSE A NETWORK on the right, the list should include one like wftrx_WFD30_6_XXXXXXX_7, where XXXXXXXX is the serial number of your unit that appears on its label. Tap that Wi-Fi Network.

You must always connect to this Network otherwise WiThrottle will not see the WFD-30.

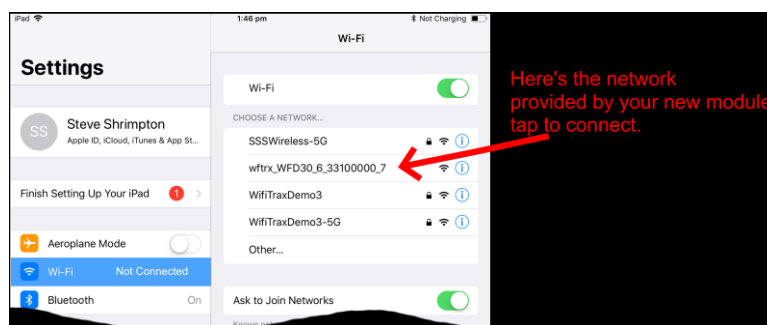

(4) No password is required and after a few moments you should see that it has connected.

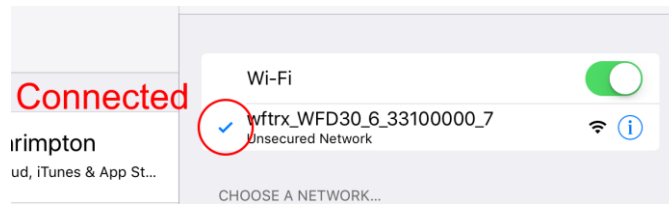

(5) Open the WiThrottle app. This app has some tabs at the bottom to select screens:



(6) You should see the connection screen headed by “wftrx_WFD30_XXXXXXX”. If not, tap the Settings tab at the bottom right, then Server Configuration at the middle left, then Current Server at the top right.

(7) The WFD-30 is a WiThrottle Server. It should appear in the AVAILABLE WITHROTTLE SERVERS section, identified by its serial number SNXXXXXXX. If it is visible, tap it and continue at (9).

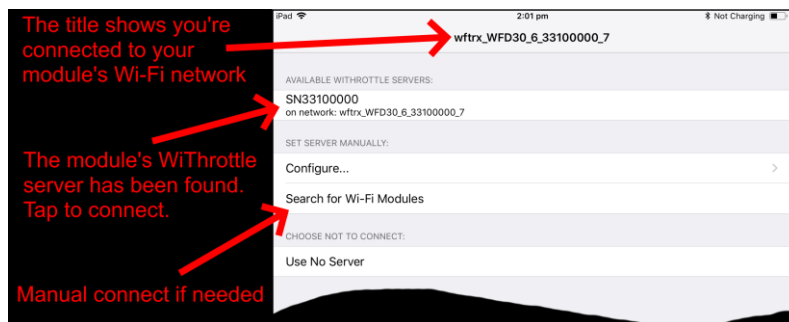

(8) If for some reason it does not appear, Set Server Manually. Tap “Search for Wi-Fi Modules”. The IP Address and port are pre-entered as 192.168.7.1 and 12090, so just tap “Connect”.

(9) Now tap the Address tab at the bottom to show the Address screen. Tap Keypad at the top-left, type the DCC address of the locomotive that you wish to drive and tap the Set button.

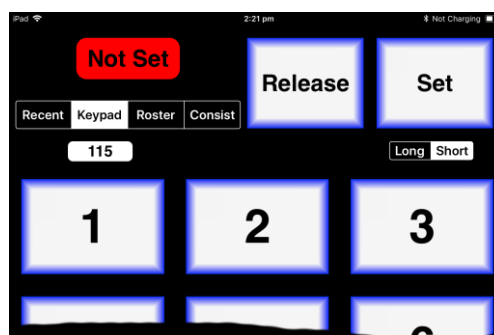

(10) Tap the Throttle tab at the bottom-left of the screen and you can begin driving.

Please consult the WiThrottle manual for more information and tips:

<https://www.withrottle.com/html/manual.html>

Please note that WiThrottle, has many features that may vary according to the version that you install. WifiTrax has no control over the features of WiThrottle, but has tested carefully its operation with our product. If you have trouble working with WiThrottle and our module, please email us your problem rather than using the WiThrottle support. WiThrottle support people do not know details of WifiTrax products, so please do not expect it. Support email: wifitrax@steveshrimpton.com or check our website.

Getting Started with Engine Driver on Android

- (1) Make sure power to your NCE Command Station and booster is on, the WFD-30 is connected and there is a locomotive on the track with a DCC address that you know.
- (2) Press the Home button and tap the settings icon on your Android phone or tablet:



- (3) Find the Wi-Fi option. On Android 7 you tap Connections on the left, then Wi-Fi on the right.

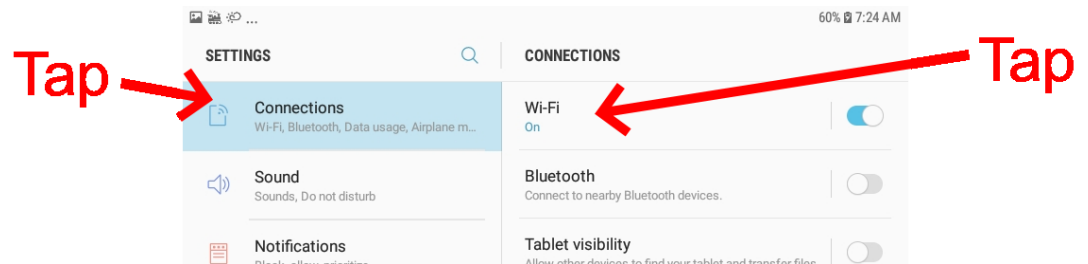

- (4) Then you see a list of available Wi-Fi Connections on the right. Look for one like wftrx_WFD30_6_XXXXXXXX_7, where XXXXXXXX is the serial number of your unit that appears on its label. Tap on that – no password is required – and wait for it to connect.

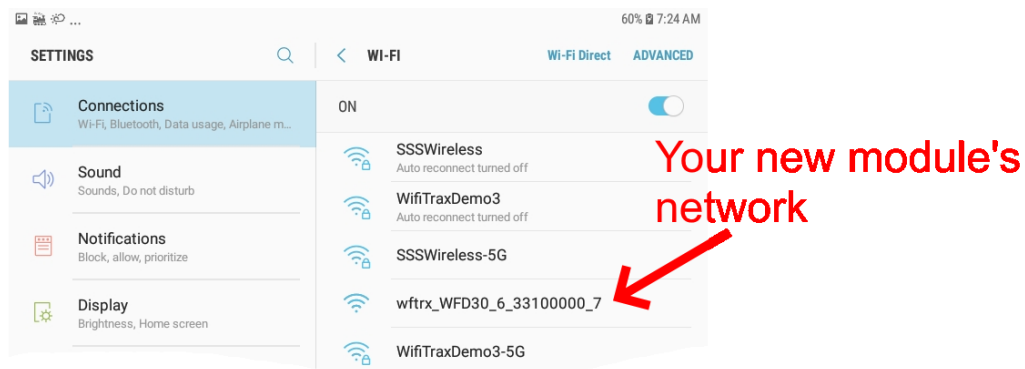

- (5) Open the Engine Driver app on your Android phone or tablet, go through its setup accepting all the defaults and allowing the privileges it requests.
- (6) After setup, you should see the "Connect to Server" page with your WFD-30 listed as a "Discovered Server". Tap on it to connect. If for some reason it is not discovered, you must type the IP Address of the WFD-30 unit, always 192.168.7.1 in the "Server Address" box at the top-left and the port value of 12090 in the port textbox, then tap the "Connect" button.

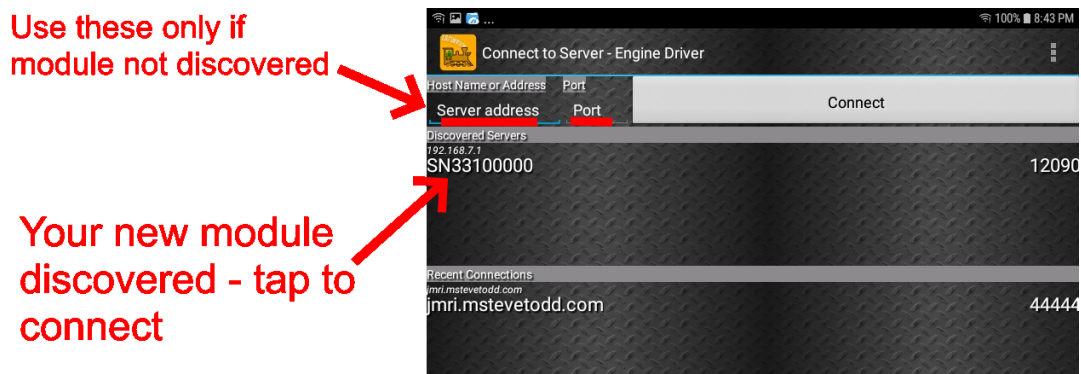

- (7) The Throttle screen should appear – ready to select a loco and drive. Tap the Select button.

- (8) On the Select/Release Loco screen, check the “DCC Address” option and type the address of your locomotive either short or long. Tap Acquire.



- (9) The driving screen appears with your DCC address as the selected loco. Try the function buttons and throttle slider to make sure your loco responds.
- (10) Please consult the Engine Driver “About” menu for more information about the app. It is possible to control more than one locomotive at a time and select different display appearances and preferences. Consult the website for more information:

<https://enginedriver.mstevetodd.com/>

Please note that Engine Driver, has many features that may vary according to the version that you install. WifiTrax has no control over the features of Engine Driver, but has tested carefully its operation with our product. If you have trouble working with Engine Driver and our module, please email us your problem rather than using the Engine Driver support. The author of Engine Driver is not likely to know details about WifiTrax products, so please do not expect it. Support email: wifitrax@steveshrimpton.com or check our website.

Getting More out of your WFD-30 and NCE Equipment

Once you are happy with simple operation using either iPhone or Android, you really must consult the full manual for information about the great features available. For example, you can:

- Make the WFD-30 automatically connect to your home Wi-Fi router on power on, using the Home Net option. That way you are not limited to four cabs and you can leave you phone or tablet connected to your home network. When you power up your NCE system, your phone or tablet will connect much more quickly.
- Use the WDM-30 web pages to set up your locomotive roster so that you can easily select from them on your iPhone or Android. You'll also be able to set each function button to show the correct text for each locomotive and decoder.
- Control DCC Accessories using WiThrottle, Engine Driver or Loco Operator.
- Use Loco Operator for other WifiTrax products such as Switch Machine, Power and Lighting.

Access the WFD-30 Manual at <http://www.wifitrax.com/manuals/WFD-30/WFD-30-Manual.pdf>

More Information

Loco Operator: <http://www.wifitrax.com/appNotes/quickStart/Loco-Operator-Quick-Start.pdf>

Other resources: <http://www.wifitrax.com/appNotes/howToArticles.html>

WifiTrax products are made in Australia using globally-sourced components and services. Check our website for warranty information.